



FLEXIBORE

250 Series

FLEXIBLE RISING MAIN

Installation Manual
&
Technical Information

Version: GE_S2017



www.crusaderhose.com.au

Contents

Introduction	3
Description	3
Advantages of Using Flexibore	4
Applications.....	4
Storage and Handling	4
Disposal.....	4
Safety	4
Hazards	5
Quality Assurance	5
Warranty	5
Specifications and Technical Data	6
Friction Loss Specifications	7
Fittings and Accessories	10
Borehole Considerations.....	12
Attach Coupling.....	13
Fitting the Power Cable.....	14
Installation Techniques	15
How to use Lifting Clamps	16
Hand Assisted with Roller Installation	17
Vehicle Assisted with Roller Installation	18
Mobile Crane Assisted Installation	19
Retrieval Techniques	20
Hand Assisted Retrieval Procedure.....	20
Vehicle Assisted Retrieval Procedure.....	20
Mobile Crane Assisted Retrieval Procedure.....	21
Hose Joiner	21
Chemical Resistance	21
Preparation and Installation Step by Step.....	22

Introduction

Flexibore is the premier Flexible Rising Main for ground water extraction using submersible pumps.

This technical manual provides specific information on storage, installation and use of **Flexibore** and associated accessories.

Crusader Hose Pty Ltd is dedicated to continual product improvement to ensure the quality and performance of **Flexibore** remains of the highest standard.

Description

Flexibore consists of a woven high tenacity strength polyester yarn (sock), totally encapsulated in polyurethane. This combination forms a strong flexible pipeline from which submersible pumps can be suspended in boreholes.

The internal 'sock' is woven on a circular loom which forms a continuous length of fabric. The woven fabric is then covered internally and externally with polyurethane. The tough polyurethane seals and protects the fabric against abrasion damage.

A strip along the length of **Flexibore** is used to anchor the control cable, at one metre intervals along the strip. The strip is hot moulded to the hose, the control cable is secured at these points.

Flexibore is specifically designed to replace metal rigid riser pipes which are subject to rust and encrustation. Rigid risers are generally heavier and more difficult to handle. PVC risers become brittle and can kink.

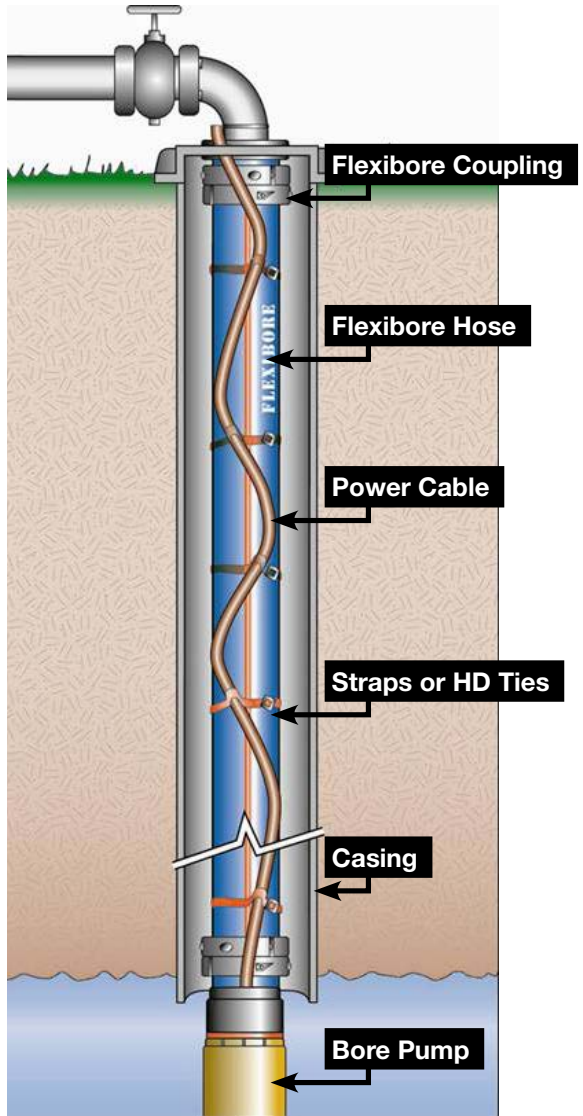

Advantages of Using Flexibore

- Is a proven alternative to steel, H.D.P.E (poly pipe), PVC and rigid fibreglass;
- Manufactured in continuous lengths exceeding 250 metres long;
- Can be installed in much less time than steel, fibreglass and most other pipes;
- Is fraction of the weight of steel or other rigid rising mains;
- Has complete resistance to corrosion and microbiological damage;
- Superior hydraulic performance;
- Is resistant to build-up of internal scale;
- Long operational life – 20 years;
- Has a 5 year Pro-rata warranty.

Applications

Flexibore has been used in a variety of new and replacement applications. These include the pumping of potable or mineral enriched ground water, regular and emergency dewatering of mines and quarries, ground water control on landfill and building sites and to create salt water barriers for the prevention of saline intrusion into potable ground water.

Storage and Handling

Flexibore is available in continuous lengths up to 500m – for longer lengths, it is normally supplied on steel/wooden drum and for small lengths on wooden stamped pallet/crate or carton but any odd or unused lengths should be coiled loosely and covered for protection. It is recommended to keep **Flexibore** out of direct sunlight if it's to be stored for a prolonged period.

Because **Flexibore** is lightweight and can be rolled up flat, an ordinary van or pick-up truck can be used to transport it to site, instead of the cumbersome vehicle necessary for rigid pipes

Disposal

Flexibore will normally be supplied cut to exact length to suit the borehole but occasionally an adjustment may be necessary on site and a length of hose found surplus to requirements. This should be disposed of properly in accordance with local / national industrial waste disposal regulations.

Safety

Flexibore is light in comparison to steel rising main and therefore presents a lesser hazard to personnel when handling.

Because **Flexibore** is supplied in continuous lengths care must be taken to ensure that it is either laid out neatly on site or coiled on a pallet or steel/wooden drum (if space is limited) whenever it is being installed or retrieved. An untidy workplace is a dangerous workplace.

Hazards

Flexibore presents no chemical or biological hazards in normal usage, nor during installation or retrieval.

If **Flexibore** is involved in a fire, during storage or transportation, **toxic & irritating gasses** may be produced – **if inhaled, medical advice should be obtained immediately.** Polyurethane material can cause **severe burns** – no attempt should be made to remove any such contamination from the skin **but should be flushed with copious amounts of cold water and medical assistance sought without delay.**

Quality Assurance

Crusader Hose Pty Ltd is an accredited manufacturer with ISO 9001:2000 Quality Management System.

Flexibore conforms to the highest standards of manufacture and has a reputation for high quality and reliability.

Each length of **Flexibore** is factory tested and issued with a serial number prior to dispatch.

For Potable Water, **Flexibore** is approved to AS 4020 standard - products for use in contact with drinking water.

Warranty

Flexibore is covered by a 5 year pro-rata warranty against faulty material or workmanship.

The warranty does not include:

- Damage resulting from forced or incorrect application;
- Misuse;
- Accidental damage; or
- Any instance where the serial number has been tampered with.

Flexibore

Flexibore will suit most borehole applications and is compatible with most submersible pumps. Manufactured in continuous lengths, **Flexibore** can be installed in less time with less labour.

Flexibore is attached to the pump with patented couplings. The pump and hose (with control cable attached) is lowered into the bore.

Specifications and Technical Data

Flexibore 250 Series							
Nominal Size (inches)	1½"	2"	3"	4"	5"	6"	8"
Internal Diameter (mm)	40	50	76	102	127	152	203
Burst Pressure (bar)	38	74	58	52	50	44	42
Max. Recommended Operating Pressure (bar)	19	37	29	26	25	22	21
Peak Tensile Load (tonnes)	2.1	3.2	8.3	10.0	14.5	16.0	22.0
Max. Recommended Tensile Load (tonnes)	1.0	1.6	4.2	5.0	7.3	8.0	11.0
Weight of Flexibore (kg per metre)	0.3	0.6	0.9	1.5	2.1	2.5	3.4
Outer Diameter of Coupling (mm)	70	90	115	140	170	190	270
Weight of Stainless Steel Coupling (kg)	1.3	2.8	5.5	7.8	11.7	13.0	41.0
Fitting Bolt Torque	10Nm	12Nm	30Nm	30Nm	40Nm	45Nm	45Nm
Weight of Water at 10% Swell (kg per metre)	1.52	2.38	5.49	9.89	15.09	21.96	31.00
Max. Flow Rate (litres per second)	4	6	18	40	55	90	148
Maximum Operating Temperature	60°C						
Water pH Range	3 to 9						
Maximum Pump Setting	250m						
Maximum Diametric Swell	15%						
Average Extension	0.5%						
Safety Factor	2:1						

* For operation beyond stated recommended operating limits, contact your **Flexibore** distributor.

Friction Loss Specifications

Due to the elongation properties of the textile sock, **Flexibore** has a built-in swell characteristic. This swelling gives excellent hydraulic performances thus keeping pumping costs down.

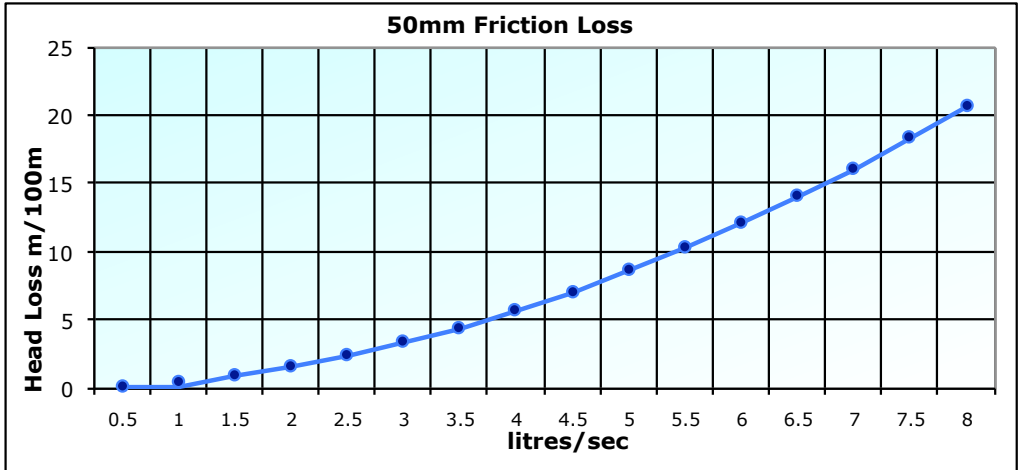
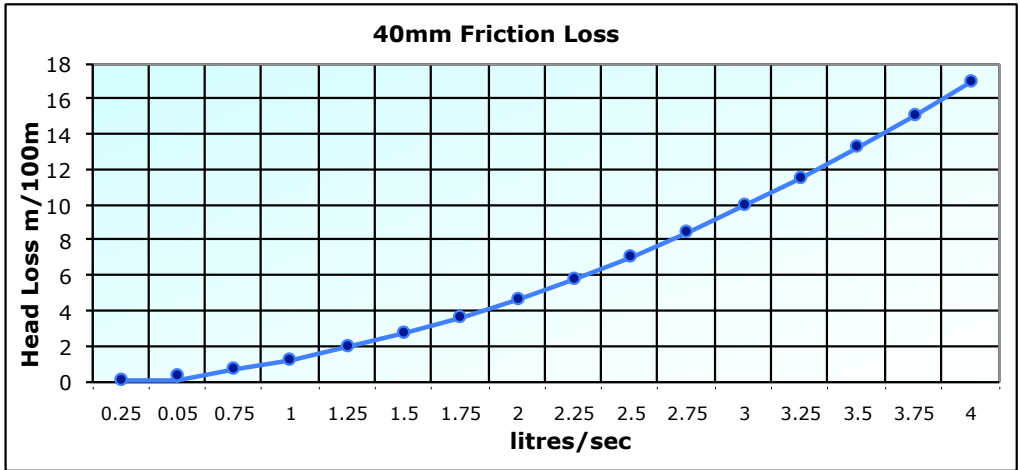

76mm Friction Loss

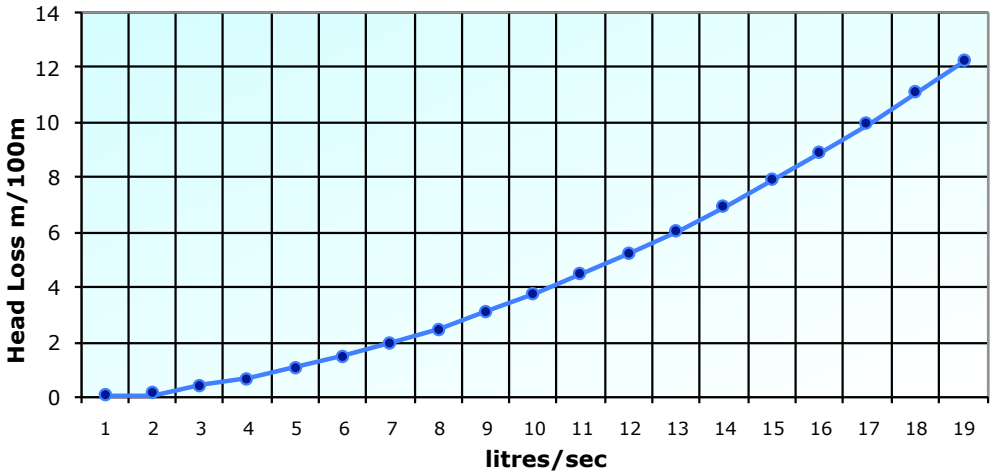

102mm Friction Loss

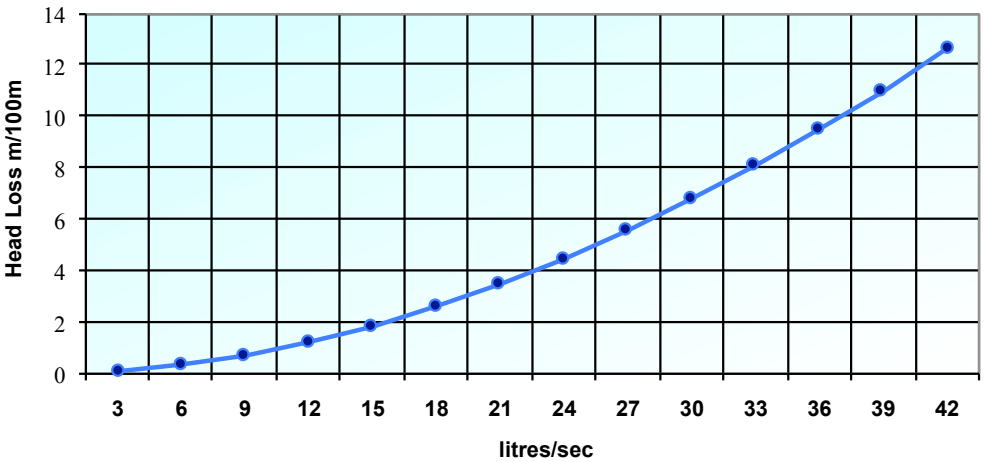

127mm Friction Loss

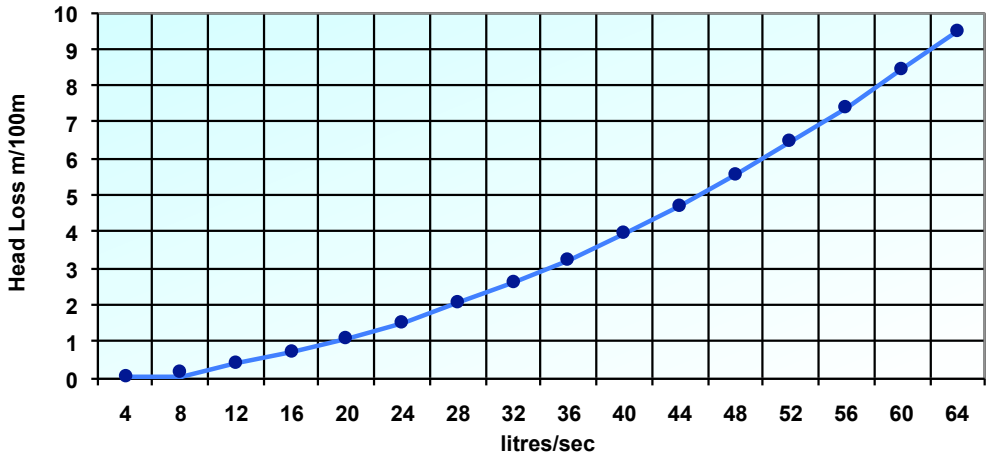

152mm Friction Loss

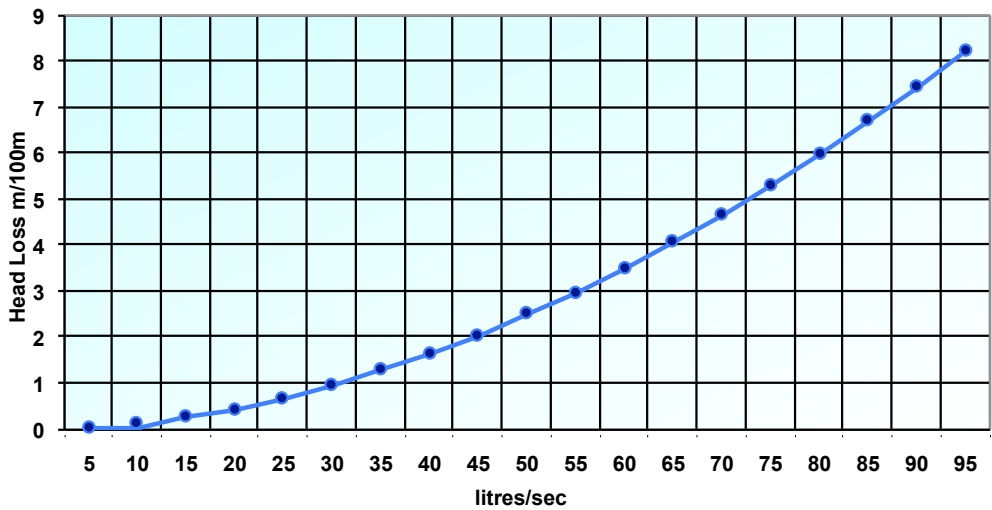

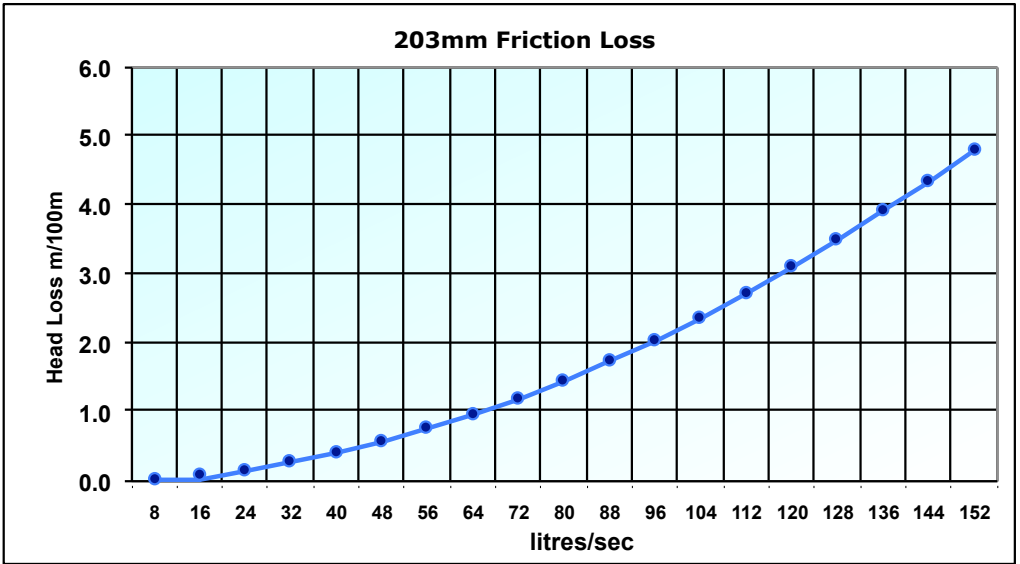

Fittings and Accessories

Couplings

Flexibore couplings are high quality engineered fittings constructed from either 304 or 316 stainless steel. Also available in duplex SAF2205.

Flexibore couplings consist of a double rib tailpiece with two 3-part clamps locking the hose immovably to the tailpiece.

Thread sizes on couplings correspond to hose size (i.e. the 4 inch coupling has a 4 inch thread).

Threads are standard B.S.P male tapered with other types and sizes available on request.

Note: Adaptors from the standard B.S.P. male coupling thread to alternative configurations are also available on request.



Break-Off Plugs (If required)



Break-off plugs are machined into the bottom coupling and used as a mechanism to permit water to escape from the riser during withdrawal of the hose from the bore-hole.

To utilize the Break-off plug for drainage, prepare a 3 - 5 kilogram steel pipe/torpedo on a lead and carefully lower into the bore. Once it has reached the break-off plug raise the string rod about 2 - 3 meters and drop to hit the plug (repeat if required). Unit plug breaks and drainage will occur.

Cable Straps

Cable straps are used to secure the control cable to the hose.

There are two types of approved cable straps for use with **Flexibore**:

- (Option 1) Polyurethane straps; and
- (Option 2) Polypropylene cable ties (both supplied by Crusader Hose)

Polyurethane Straps (Option 1)

Polyurethane straps are 2.0 mm thick and approximately 18 mm wide and have cam-locking buckles.

The straps wrap around the riser and the electrical cable. The length of the straps depends on the size of hose used:



2" hose: 550 mm long strap

3" hose: 850 mm long strap

4" hose: 1000 mm long strap

5" hose: 1150 mm long strap

6" hose: 1300 mm long strap

8" hose: 1800 mm long strap

Note: No steel parts are used to prevent damage in case of accidental breakage of a strap.

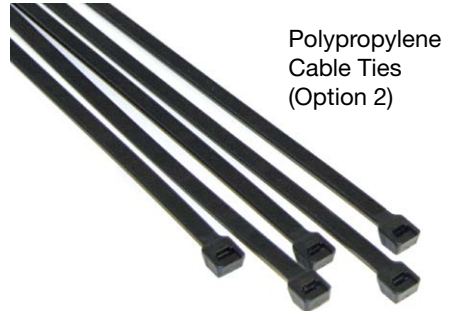
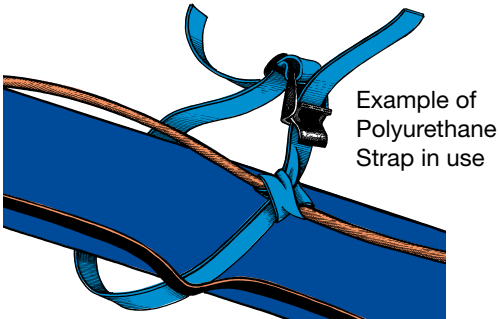

Polypropylene Cable Ties (Option 2)

Heavy duty cable ties (supplied by Crusader Hose) can also be used to secure the control cable to the hose.

Two cable ties are used for each cable loop located every 1m along the length of the hose.

Adaptors and Sockets

High quality stainless steel adaptors and sockets that can be used in conjunction with **Flexibore** couplings are also available.

Non Return Valve

The Non return Valve can be drilled out from the submersible pump. This is a quick and easy option to drain the riser for easier retrieval.

Bore Cap

Stainless Steel or Galvanised bore caps are used at the bore head.



Lifting Clamps

Lifting clamps are used with a winch or vehicle to raise and lower the riser.

- Light duty clamps are used where the maximum load is limited to 1.3 tonnes.
- Heavy duty clamps are used where the load exceeds 3.0 tonnes (to a maximum load of 4 tonnes).



Bore Cap

Installation Roller Assembly

A roller assembly above the borehole can be used to assist to lower or lift the riser.

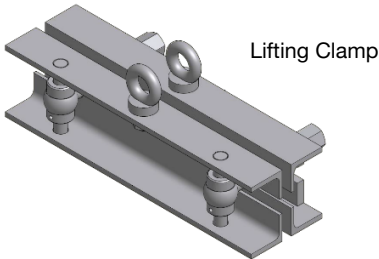

Lifting Clamp

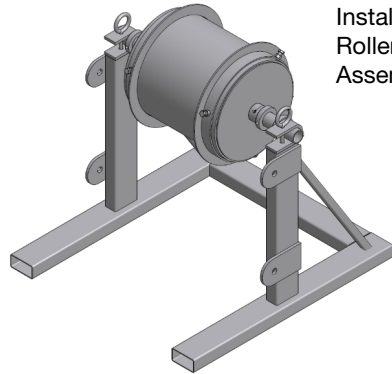

Installation Roller Assembly

Borehole Considerations

Assembly and Installation of Flexibore Rising Main:

Flexibore Diameter Maximum		Maximum lay-flat with coupling Width		Minimum Bore Casing Requirement Diameter	
Nominal Size (inches)	Internal Diameter (mm)	Nominal Size (inches)	Internal Diameter (mm)	Nominal Size (inches)	Internal Diameter (mm)
1.5"	40	2.9"	70	3"	76
2"	50	3.5"	90	4"	102
3"	76	4.5"	115	6"	152
4"	102	5.5"	140	8"	200
5"	127	6.8"	170	10"	252
6"	152	7.5"	190	12"	302
8"	203	10.7"	270	16"	402

**The borehole diameter must allow adequate clearance for the power cable(s) and any additional equipment.*

Tools Required for Installation/Retrieval

Ensure you have the following on site:

- Submersible Pump.
- Base plate and wellhead/ bore cap assembly.
- The required length of Flexibore.
- Electrical cable, equal to the length of Flexibore plus 5% minimum.
- Two Flexibore Couplings.
- Sufficient Flexibore Polypropylene Cable Ties / Polyurethane Straps.
- Short lengths of Polyethylene or PVC hose to act as a cable guard.
- 2 sets Flexibore Lifting Clamps or rated slings.
- Crane or Vehicle or Crusader Installation Roller.

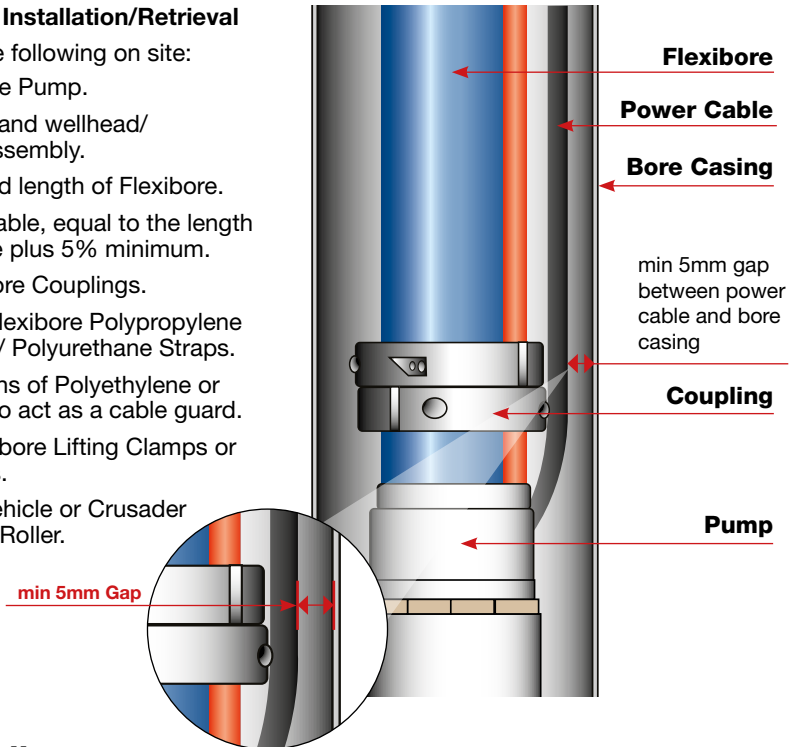

Attach Coupling

Note: The coupling clamps can be fitted to the hose without the need to file down the orange strip.

- 1) Connect the coupling to the Flexibore riser (if there is sufficient room, fully unroll the riser and power cable).
- 2) To connect the coupling: Inspect the end of the riser. If uneven, trim the riser so that the end of the hose is square.
- 3) Stand the tail piece on the ground and push the riser onto the tail piece until it butts cleanly against the square shoulder of the hose (this does not require lubricant, which should not be used).
Note: it is difficult to push the riser onto the hose tail, cut two small slits opposite each other in the end of the hose (no more than 10 mm long).
- 4) Assemble a three-piece clamp ring over the riser and locate it approximately 6 mm to 7 mm from the shoulder of the coupling. Tighten the cap screws evenly so that there is approximately a 2 mm gap between each of the clamp segments.



- 5) Assemble the second three-piece clamp ring over the riser and locate it against the first clamp. Rotate the clamp so that gaps between the segments of the second clamp line up with the middle of the segments of the first clamp (in other words - offset the gaps between the segments of the two clamps in relation to each other).
- 6) Tighten the cap screws evenly so that there is approximately a 2mm gap between each of the clamp segments. Firmly tighten the cap screws of both clamps.
- 7) Fit a protective sleeve to act as a guard over the Power cable where it will pass over the coupling and secure with PVC Tape.

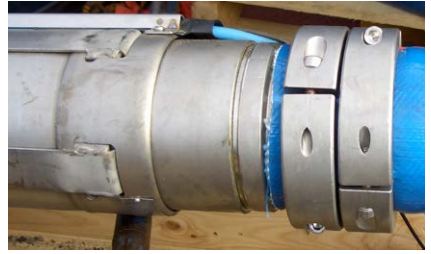

Fitting the Power Cable

Most installation issues occur at this stage. Please read carefully!

Roll the power cable out next to the riser, allowing a slack of 5%.

Securing with Polyurethane Straps (Option-1)

The **Flexibore** riser should be laid on the ground with the rib facing up.

- One Polyurethane Strap per meter for 3 inch (76mm) to 8 inch (200mm) diameter.
- One Polyurethane Strap every 2 meter for 1½" inch (40mm) and 2 inch (50mm) diameter.



Preparation:

Thread the strap under each loop on the strip along the hose length. Maximum 2m intervals.

Securing the power cable:

Ensure that the power cable is secured firmly to the strap using a clove-hitch knot shown.



Tightening the power cable:

The power cable should not be able to slip through the knot so pull it up tightly.

Buckle position:

Keep the buckle on the same side as the power cable to prevent it being crushed when going over the installation roller.



Snake the cable to insure the riser takes the full weight:

Allow approx. 5% slack in the power cable.

Lastly insert the strap onto the triangular buckle to finish.

Note: Securing the Power cable correctly to the hose makes for trouble-free pumping.

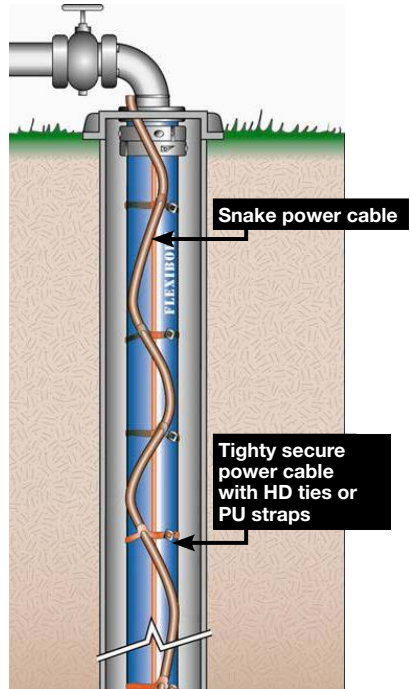

Securing with Polypropylene Cable Ties (Option-2)

Note: It is imperative that only the approved cable ties are used. When fitting this type of tie, 2 ties must be used for each loop along the length of the hose.

Follow these steps:

- 1) Use two approved cable ties per loop.
- 2) Ensure cable ties are spread apart near loop ends.
- 3) Pull the tie up very tight ensuring that the power cable cannot slide through and trim off excess cable tie.
- 4) "Snake" power cable to allow for 2% elongation to compensate for the weight of the pump and water etc. Normally 5% extra Power cable must be supplied.

Note: Do not attach any high or low level probes cased in PVC, as this pipe can become brittle. Probes should be hung independently in the bore.

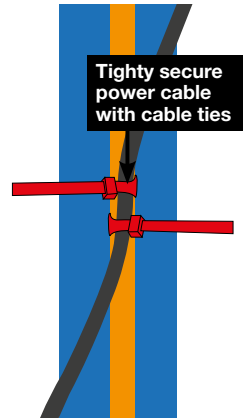

Installation Techniques

There are three methods usually employed to install a **Flexibore** rising main:

- Hand assisted;
- Vehicle assisted; and
- Mobile crane assisted

The method used is generally dependant on the bore depth, pump weight and site access.



How to use lifting clamps

Two (single set) x Lifting Clamps are required.

- Lifting clamps are used in conjunction with a winch or crane to raise and lower the riser.
- Light duty lifting clamps are used where the maximum load is limited to 1.3 tonnes.
- Heavy duty lifting clamps are used where the load exceeds 3 tonnes (to a maximum load of 4 tonnes).
- Lifting Clamps available in: 1.3t, 3.5t & 4t ratings

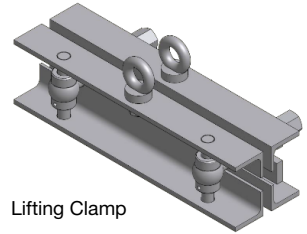

Lifting Clamp

CAUTION: The lifting clamp used should be selected based on the maximum load of the riser during installation.

- 1) Fit the **FIRST** lifting clamp just above the first coupling (lay the power cable outside the clamp – NOT underneath it)
- 2) Make sure the 2x swing bolts are tightened, now the **FIRST** lifting clamp is secured onto the Flexibore riser.
- 3) Attach the crane hook into the lifting clamp eye bolt then carefully rise the riser around 5 – 10m along the riser (depending on the crane lifting height capacity) then lower it down into the bore until the **FIRST** lifting clamp rest on the bore casing.
- 4) With the **FIRST** lifting clamp resting against the bore casing. Secure the **SECOND** lifting clamp around 5 - 10m along with the riser (depending on the crane lifting height capacity).
- 5) Once the **SECOND** lifting clamp is tightened/ secured on the Flexibore riser. Then slowly rise the riser until the **FIRST** lifting clamp is free then removed the **FIRST** lifting clamp and carefully lower the **SECOND** lifting clamp until it sits against the bore casing. **Repeat until the bore cap is fitted over the bore.**

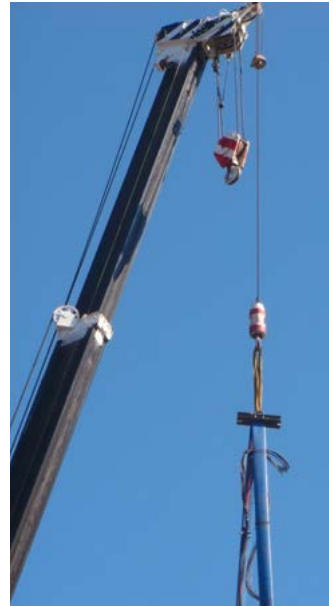

Hand Assisted with Roller Installation

The equipment required for a typical hand assisted installation include:

- Two single set lifting clamps (Light duty only - depending on pump weight).
- A roller assembly

Hand Assisted Procedure:

CAUTION: Make sure sufficient and accurate information is calculated for suitability walked-in by hand assist installation – total weight of the pump, power cable and **Flexibore** riser must be established.

- 1) Position the pump alongside the borehole.
- 2) Fit the first clamp just above the first coupling (**lay the power cable outside the clamp – NOT underneath it**).
- 3) Carefully raise the pump & position over the borehole and lower the riser until the first clamp rests on the bore head casing.
- 4) Position and secure the roller assembly above the borehole and power cable must be over the roller.
- 5) Two operators may be required (depending on the pump weight) to take the tension of the Flexibore riser by hand slowly lifting the riser. Remove the first clamp then slowly walked in to lower the pump (assuring the power cable, straps/cable ties and the riser is not touching the edge of the casing to avoid serious damage).
- 6) Once the end of the Flexibore riser reaches the roller carefully position the second clamp resting on the bore head casing. Secure the second coupling at the end of the riser and headwork.
- 7) Remove the second clamp and finally lower the whole assembly.



Vehicle Assisted with Roller Installation

The equipment required for a typical vehicle assisted installation include:

- Two single set lifting clamps (light or heavy duty depending on pump weight).
- A roller assembly.

Vehicle Assisted Procedure:

- 1) Position the pump alongside the borehole.
- 2) Connect the couplings to the Flexibore riser.
Optional: First coupling – may have Break-off plug or a Non-Return Valve drilled.
- 3) Fit the pump to the first coupling (use adaptors and fittings as required).

CAUTION: The lifting clamp used should be selected based on the maximum load of the riser during installation.

- 4) Fit the second coupling and bore cap.
- 5) Fit the first clamp just above the first coupling (**lay the power cable outside the clamp – NOT underneath it**).
- 6) Position and secure the roller assembly above the borehole.
- 7) Raise the pump into position above the borehole. Lay the riser and power cable over the roller assembly and carefully lower the pump into the casing until the lifting clamp is supporting the pump on the bore head casing or on clamp supports.
- 8) Secure the power cable along the Flexibore riser with the straps or cable ties provided. Allow minimum 5% extra power cable to cover riser elongation under maximum load. Leave power cable 'bowed' or 'snake' between strapping points.
- 9) Fit the second clamp on the other end of the Flexibore riser with the bore cap & attach to the vehicle and slowly reverse the vehicle to lift the pump slightly releasing the first clamp (**by removing the first clamp the vehicle is taking the full weight of the pump**).
- 10) Slowly drive the vehicle forward to lower the pump until the second clamp reaches the roller assembly. Making sure the cable straps/ties are over the roller as the Flexibore riser is lowered (**do not run the lifting clamps or couplings over the roller**).
- 11) Secure the Flexibore riser with the second clamp on top of the bore head casing resting, now holding the riser.
- 12) Raise the Bore Cap until the second clamp is lifted out of the bore and remove. Lower the assembly onto the borehole.
- 13) Fit the final bore head discharge assembly.



Mobile Crane Assisted Installation

The equipment required for a typical crane assisted installation include:

- Two single set lifting clamps (Light or heavy duty depending on pump weight).
- A mobile crane with required lifting capability.

Mobile Crane Assisted Procedure:

- 1) Connect the first coupling to the Flexibore riser
Optional: First coupling – may have break-off plug or Non Return Valve drilled.
- 2) Unroll the Flexibore riser along the ground. Lay the power cable next to the riser along the length.
- 3) Position the pump next to the Flexibore riser. Connect the power cable to the pump.
- 4) Secure the power cable along the Flexibore riser with the straps or cable ties provided. “Snake” power cable to allow for approx. 2% elongation to compensate for the weight of the pump and water. Normally 5% extra power cable must be supplied.
- 5) Attach the first clamp to the crane hook and raise the Flexibore riser slowly to a sufficient height **(make sure power cable is always outside the clamp)**.
- 6) Slowly lower the pump to the borehole until the first clamp is supported on the bore head casing.
- 7) Secure the second clamp at the maximum lifting height to the Flexibore riser less 30 inches (762mm). The power cable must be attached to the riser “tightly” and “Snaked” so after the first clamp has been removed there is no excess slack.
- 8) Repeat this operation as many times as required to install the pump down the borehole
(ensure the section of Flexibore riser and power cable is not dragged over the edge of the casing, as this will cause serious damage).
- 9) On the last raise attach the second coupling to the bore cap, secure the bore cap and lift with the crane, remove the second clamp and finally lower assembly.



Retrieval Techniques

Retrieval usually depends on whether the pump has a break-off plug or the non-return valve has been drilled out.

- Hand assisted;
- Vehicle assisted; and
- Mobile crane assisted.

Make sure the retrieval devices (by hand, vehicle or mobile crane) can accommodate the full load of the **Flexibore** system during removal.

Hand Assisted Retrieval Procedure

- 1) Stop the pump and allow the water to drain down to the static water level. Allowing 35 seconds per meter.
- 2) Disconnect the electrical supply and discharge pipe work.
- 3) Connect a safety chain cable to the bore cap, secure it to the roller assembly for safety and carefully lift the riser out of the borehole. Fit the first clamp to the riser securely resting on the bore head casing (**do not clamp the power cable**).
- 4) Secure and position the riser over the roller assembly - prepare one or two operator(s) to walk out with the riser from the borehole and slowly lift and remove the first clamp (**by removing the first clamp, the operators taking the full weight of the pump**). Stop and wait to allow the water to drain - If required secure the riser with the second clamp while drainage occurs. Repeat if necessary.
- 5) Once the riser is out of the bore and resting on the ground, remove the bore cap and the outer clamps from the top coupling (**do not cut the riser**).

When the Flexibore system is ready to be reinstalled, double check all straps/cable ties are in good condition, replace if necessary.

Vehicle Assisted Retrieval Procedure

- 1) Stop the pump and allow the water to drain down to the static water level. Allowing 35 seconds per meter.
- 2) Disconnect the electrical supply and discharge pipe work.
- 3) Connect a safety cable to the bore cap secure to a tripod or crane on truck for safety and carefully lift the riser over the roller assembly out of the borehole. Secure the first clamp to the riser resting on the bore head casing (**do not clamp the power cable**) and attached the second clamp to the vehicle.
- 4) Drive the vehicle slowly away from the borehole. Stop and wait to allow the water to drain - If required secure the second clamp to the riser while drainage occurs.
- 5) As the pump gets closer the top of the borehole, secure the Flexibore riser with the clamp and rest on top of the bore head casing to drain the riser.
- 6) Once the riser is out of the bore and resting on the ground, remove the bore cap and the outer clamps from the top coupling (**do not cut the riser**).

When the Flexibore system is ready to be reinstalled, double check all straps/cable ties are in good condition, replace if necessary.

Mobile Crane Assisted Retrieval Procedure

- 1) Stop the pump and allow the water to drain down to the static water level. Allowing 35 seconds per meter.
- 2) Disconnect the electrical supply and discharge pipe work.
- 3) Raise the bore cap off the borehole, using crane and carefully lift to 3 - 4 meters above the borehole. Secure the Flexibore riser with the first clamp.
- 4) Lower the riser to allow the clamp to take the full-load.
- 5) Lower the bore cap to the ground and remove it from the riser **(do not clamp the power cable)**.
- 6) Carefully raise the Flexibore to the maximum height allowed by the crane then secure the riser with the second clamp resting on the top of the bore and slowly lower the first clamp from the crane on the ground and remove it from the riser.
- 7) Repeat this procedure when required until the pump is lifted out of the bore.

When the Flexibore system is ready to be reinstalled, double check all straps/cable ties are in good condition, replace if necessary.

Hose Joiner

In some circumstances existing riser may require additional lengths. In this case a hose joiner is introduced.

Note: Joiner must be positioned at the top of the system.



Chemical Resistance Chart

Flexibore is manufactured from polyurethane which has a high chemical resistance to a wide range of chemicals. However certain chemicals in concentrated form, may have a detrimental effect on the hose. This can result in cracking without any effect or risk of the pump coming off, due to the fabric structure of the hose remaining intact and unaffected.

In case of high chlorine levels, we recommend using our annealed version of the Flexibore hose, which has been heat treated. This annealing process significantly improves the chemical resistance capabilities of Flexibore.

Preparation and Installation

Step 1

Screw bottom coupling tightly to pump.

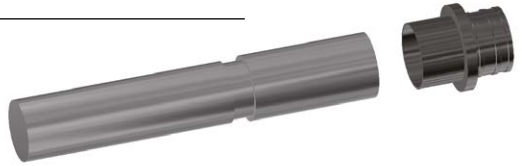

Step 2

Prepare bore cap with top coupling.

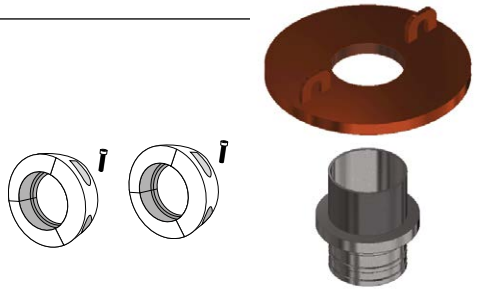

Step 3

Connect hose to coupling and attach clamps.

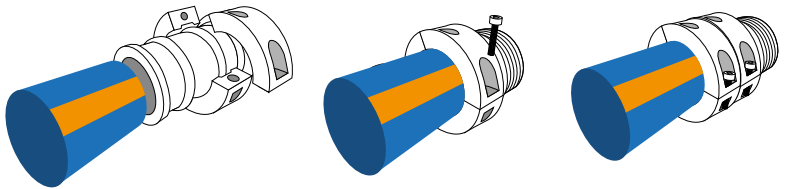

Step 4

Snake power cable and attach securely using cable ties or PU straps

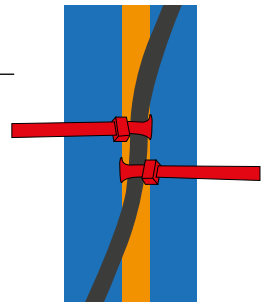

Step 5

- Flexibore installation over a roller assist

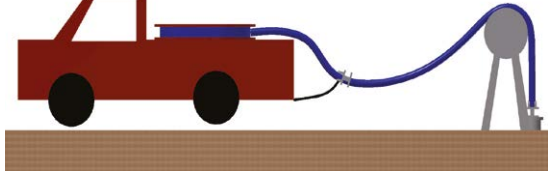
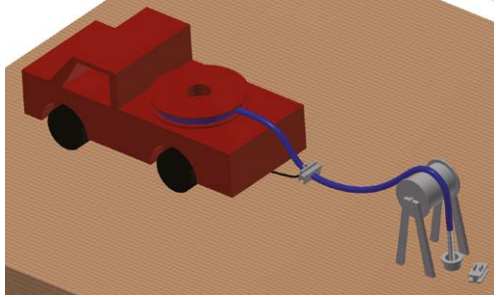
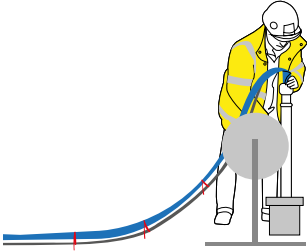

- Flexibore installation Crane on truck assist

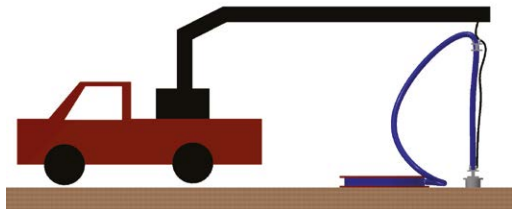
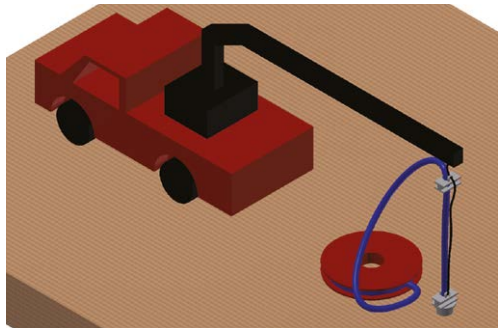
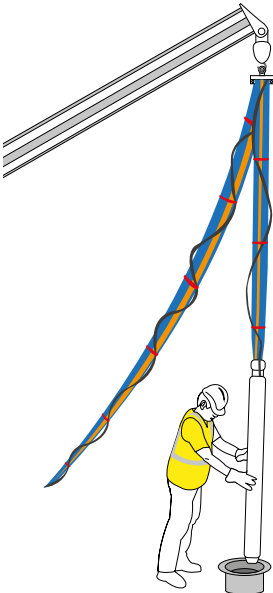

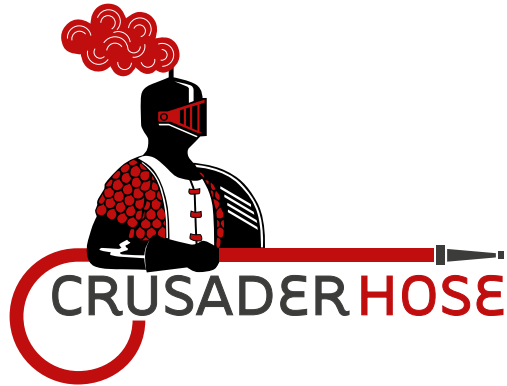

For more information contact your nearest Flexibore distributor:

Crusader Hose Pty Ltd

22 Industry Place Bayswater VIC 3153 Australia

Telephone: +61 3 9720 1100

Facsimile: +61 3 9720 5756

Email: sales@crusaderhose.com.au

www.crusaderhose.com.au